

LEDA

25/2602.xx

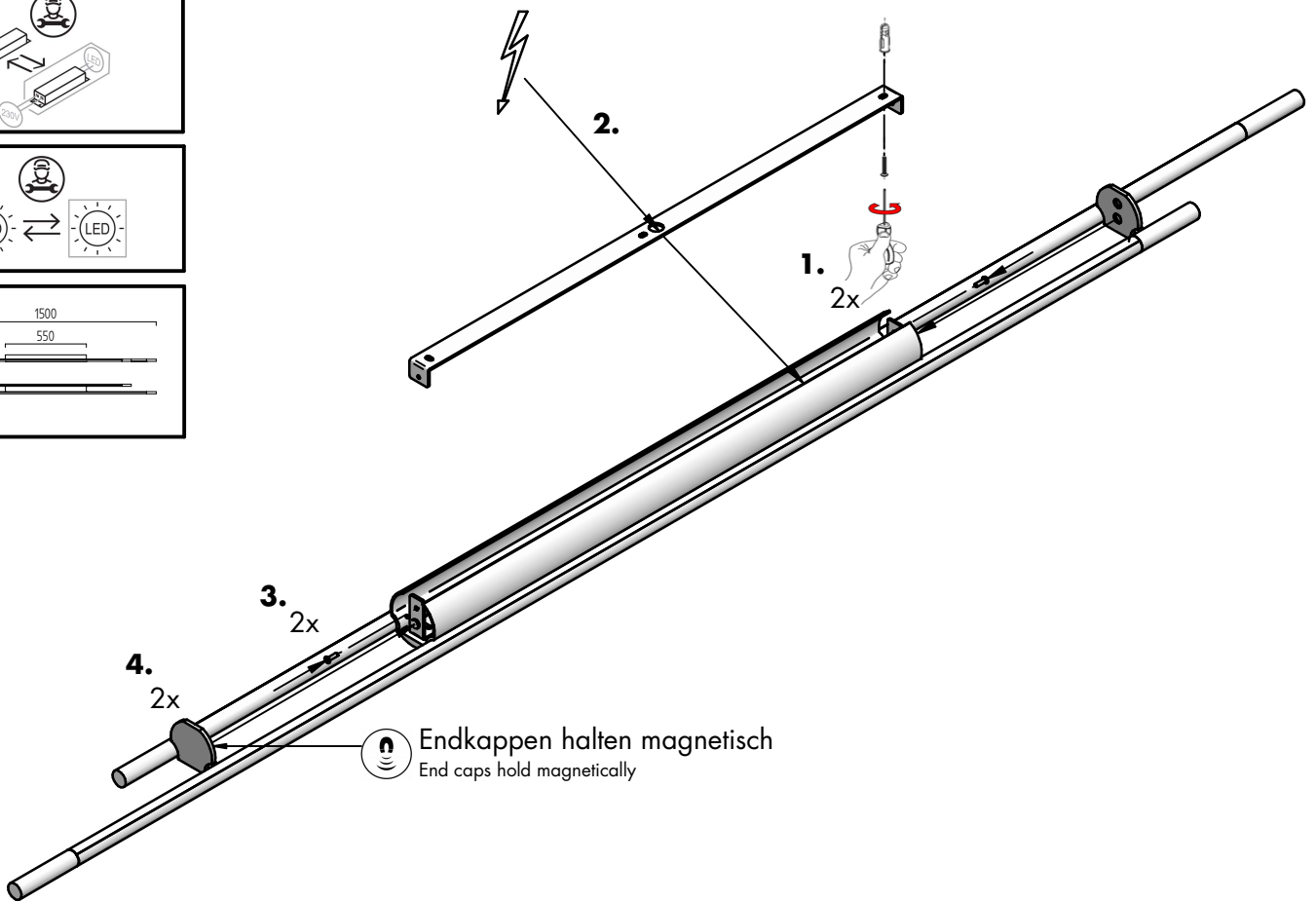
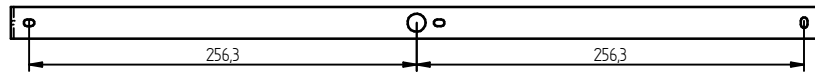
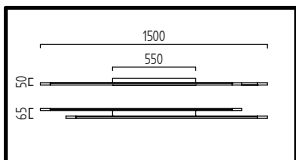
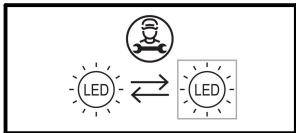
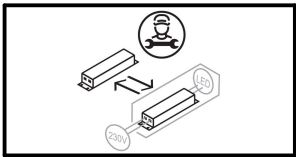
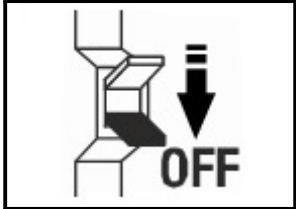

FR
Cet appareil se recycle
À DÉPOSER EN MAGASIN
OU
À DÉPOSER EN DÉCHÈTERIE

Points de collecte sur www.quefairedemesdechets.fr

Bitte beachten Sie unsere allgemeinen Hinweise !
Please observe our general information !
Nous vous prions d'observer nos instructions générales !
Observe por favor nuestra información general !

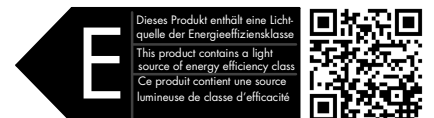

www.helestra.de/installation